

U069A

X: 0 mm

Y: 0 mm

Z: 0 mm

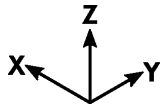

X: 990 mm

Y: 495 mm

Z: 350 mm

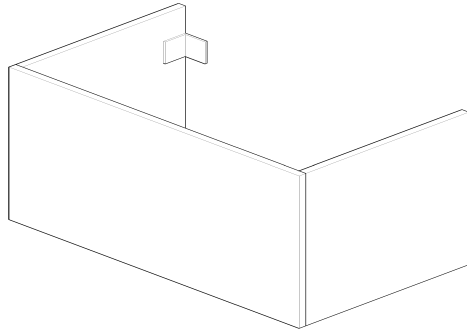
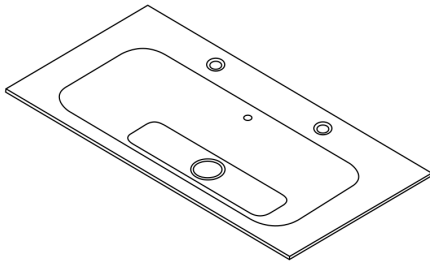

A



B



- A 560 mm
- B 610 mm
- C 80-120 mm
- D 495 mm
- E ... mm
- F 390 mm
- G 691 mm
- H ... mm
- I ... mm
- J 860 mm
- M 51 mm
- N mm

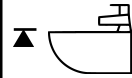
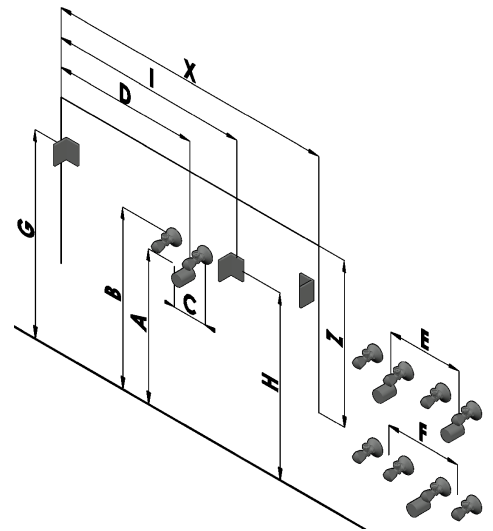

J

Art.No



max. 50 Kg

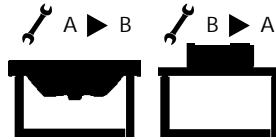
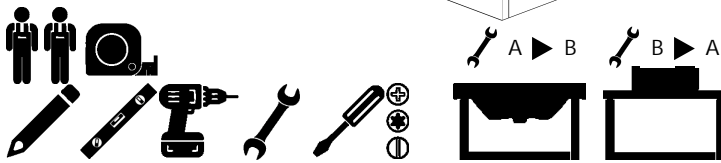
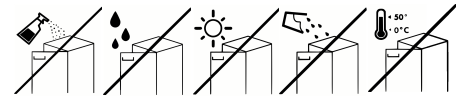

A

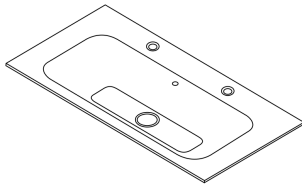

~~SILICONE~~

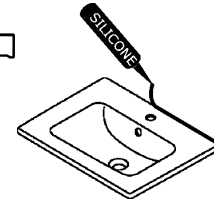

B

