



U023

X 600 mm
Y 470 mm
Z 130 mm



X 1000 mm
Y 500 mm
Z 370 mm

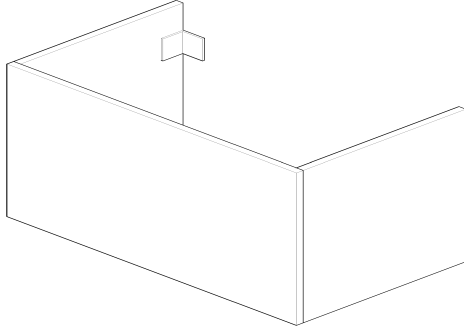
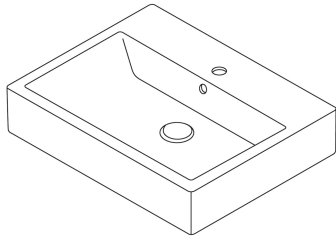

- A 550 mm
- B 600 mm
- C 80-120 mm
- D 500 mm
- E ... mm
- F ... mm
- G 642 mm
- H ... mm
- I ... mm
- J 860 mm
- M 71 mm
- N ... mm

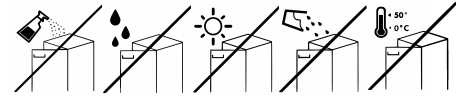
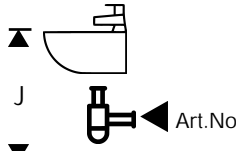
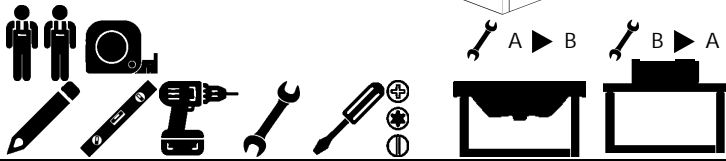
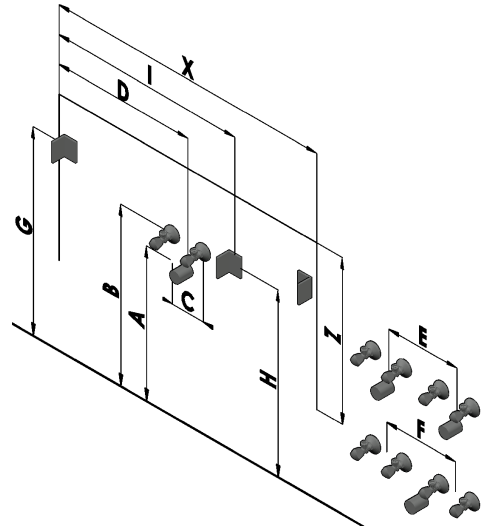

A

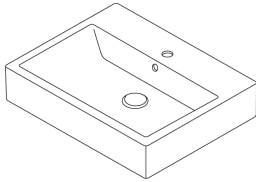

~~SILICONE~~

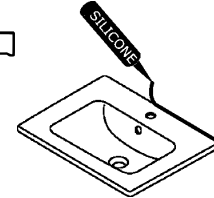
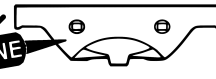

B

