

XXX

X 0 mm

Y 0 mm

Z 0 mm

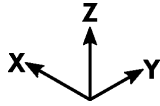

X 600 mm

Y 500 mm

Z 370 mm

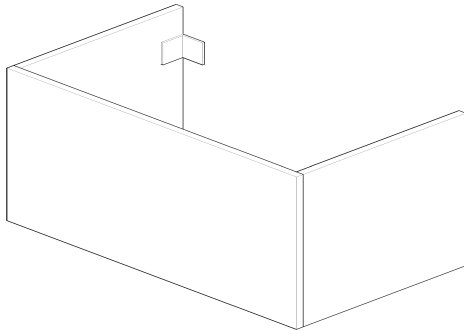

A



B



A mm

B mm

C mm

D mm

E mm

F mm

G mm

H mm

I mm

J mm

M 71 mm

N mm

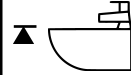
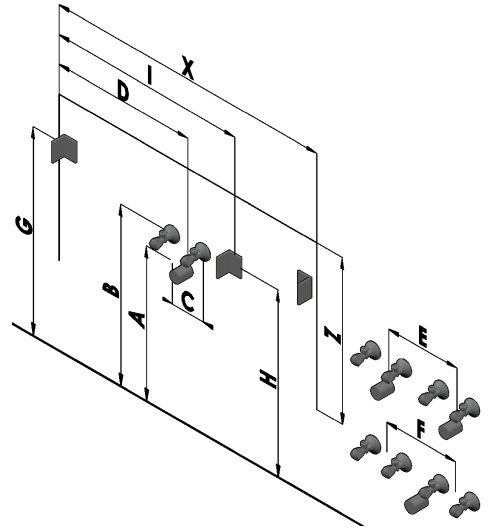

J

Art.No

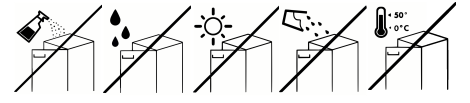
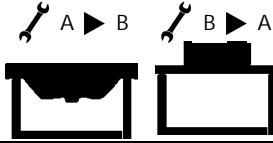
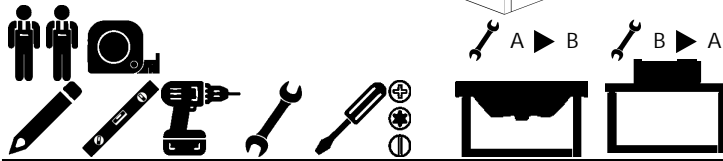

A

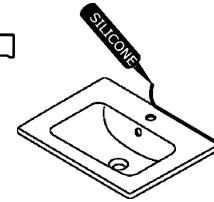
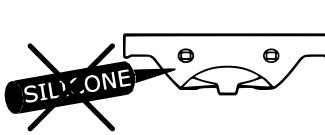

B

