



U114

X₁ 1195mm

Y₁ 460mm

Z₁ 60mm

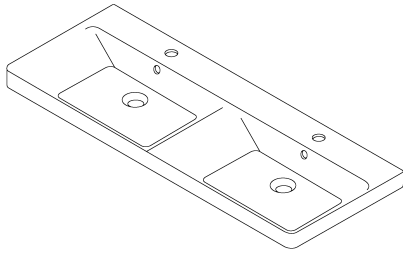

X 1160 mm

Y 445 mm

Z 560 mm

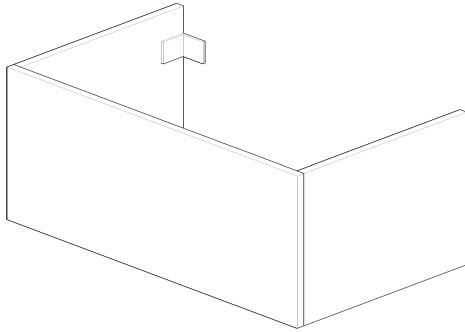

- A 550 mm
- B 580 mm
- C 80-120 mm
- D 285 mm
- E 590 mm
- F 590 mm
- G 662 mm
- H 635 mm
- I 617 mm
- J 860 mm
- M mm
- N mm

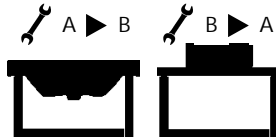

! A=B

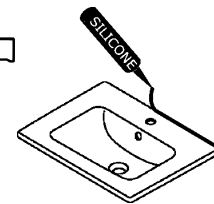
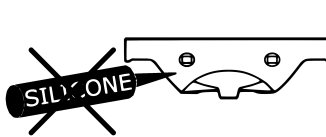
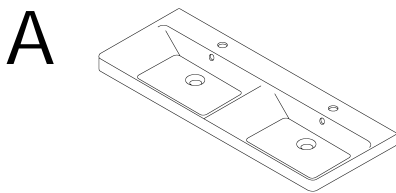
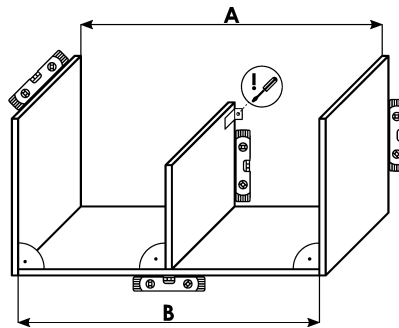

B

