



U017

X: 800mm

Y: 475mm

Z: 110mm

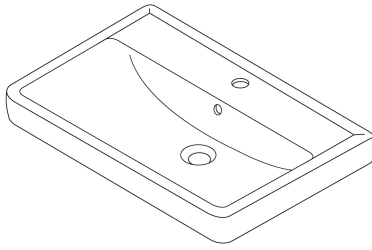

X: 745 mm

Y: 436 mm

Z: 560 mm

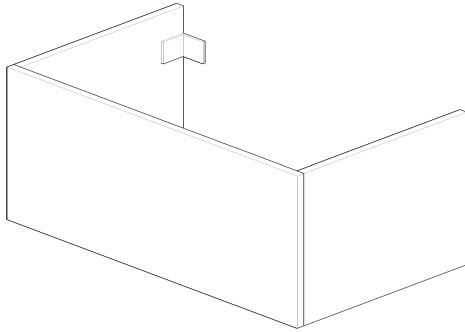

A



- A 540 mm
- B 570 mm
- C 80-120 mm
- D 373 mm
- E --- mm
- F --- mm
- G 640 mm
- H --- mm
- I --- mm
- J 860 mm
- M mm
- N mm

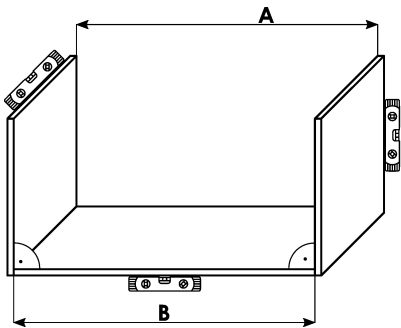
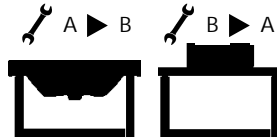
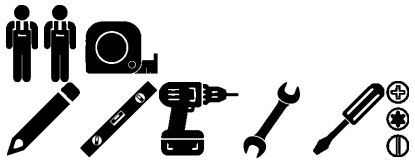
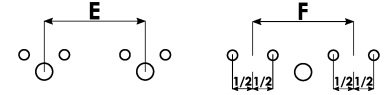
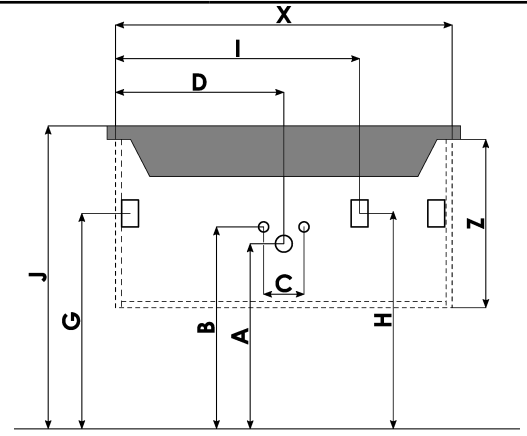

! A=B

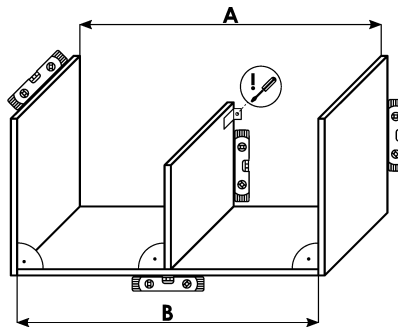

A

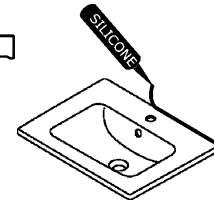
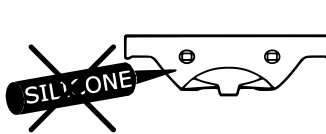
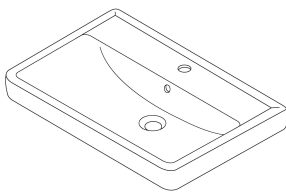

B

