



U115

X: 600mm

Y: 455mm

Z: 100mm



X: 2400 mm

Y: 500 mm

Z: 418 mm

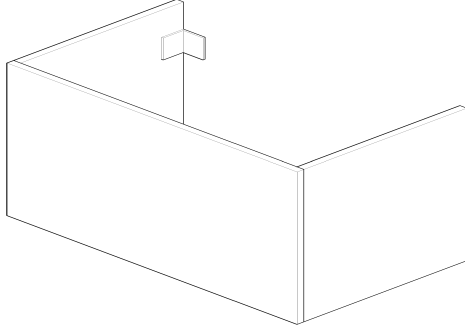
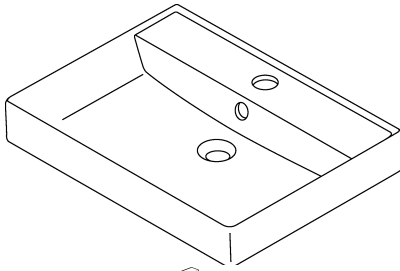

A



- A 560 mm
- B 600 mm
- C 80-100 mm
- D 402 mm
- E 1596 mm
- F ... mm
- G 691 mm
- H 691 mm
- I 752/849/1550/
1647/2348 mm
- J 860 mm
- M mm
- N mm

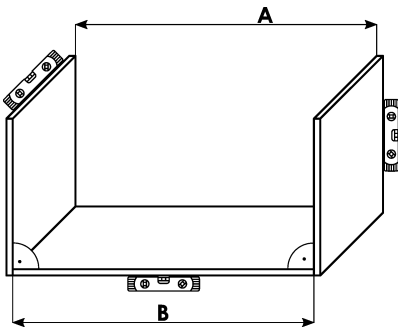
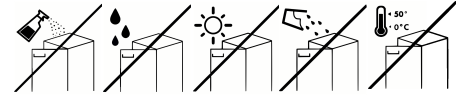
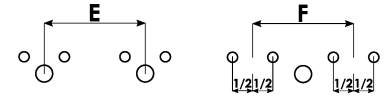
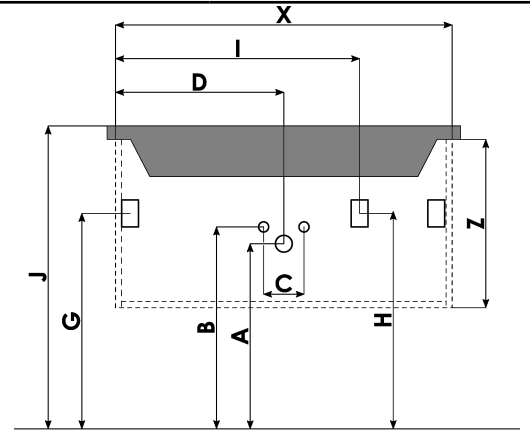

! A=B

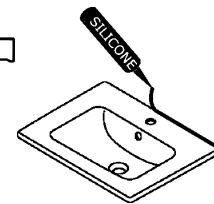
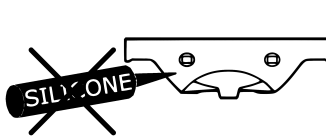
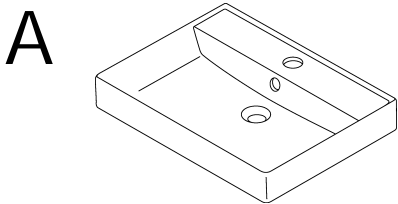
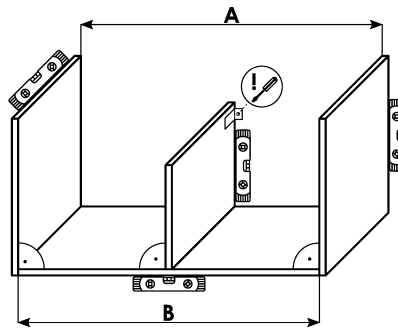

B

