



U116

X: 700mm

Y: 455mm

Z: 100mm



X: 2000 mm

Y: 500 mm

Z: 418 mm

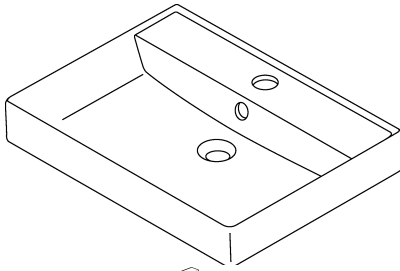

A



- A 560 mm
- B 600 mm
- C 80-120 mm
- D 501 mm
- E 998 mm
- F ... mm
- G 691 mm
- H 691 mm
- I 951/1048/1949 mm
- J 860 mm
- M mm
- N mm

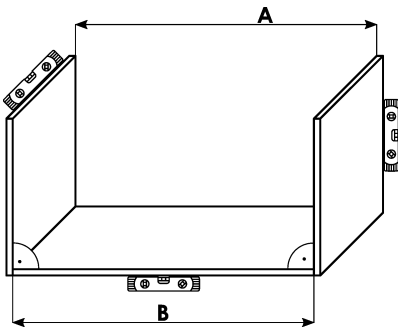
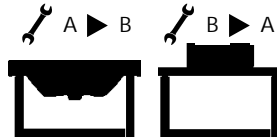
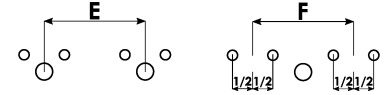
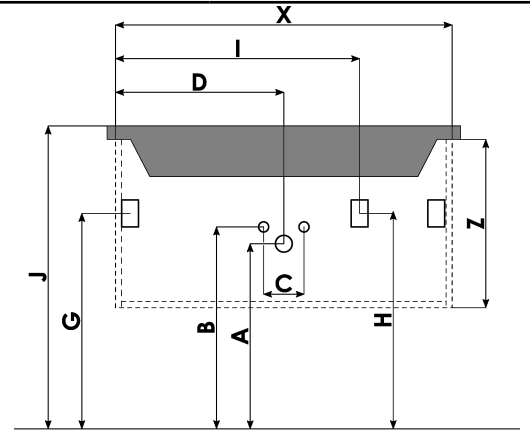

! A=B

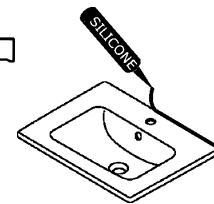
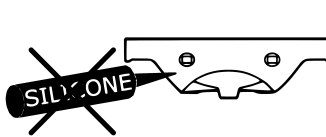
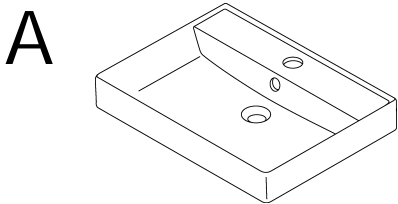
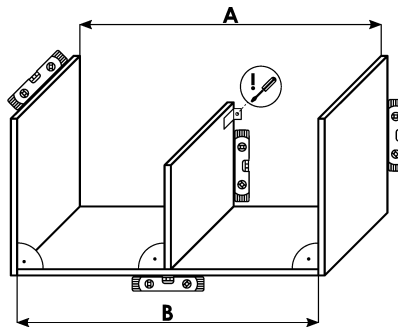

B

