



U117

X: 850mm

Y: 455mm

Z: 100mm



X: 1200 mm

Y: 500 mm

Z: 218 mm

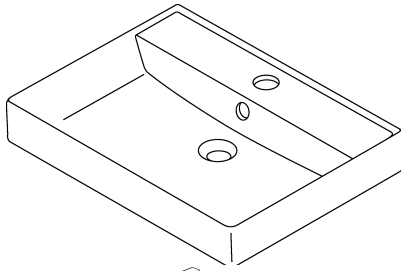

A



- A 510 mm
- B 650 mm
- C 80-100 mm
- D 600 mm
- E ... mm
- F ... mm
- G 691 mm
- H 671 mm
- I 478/722 mm
- J 860 mm
- M mm
- N mm

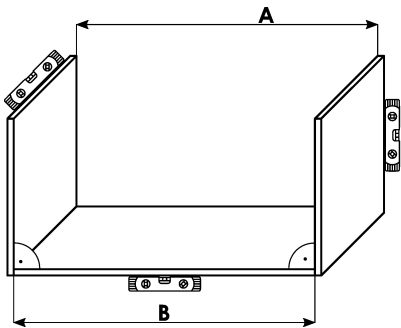
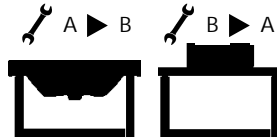
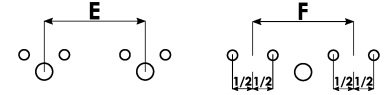
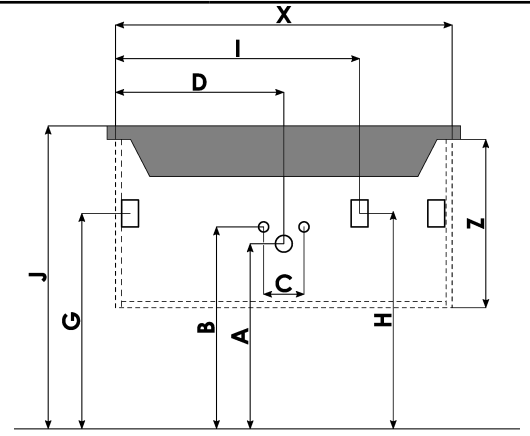

! A=B

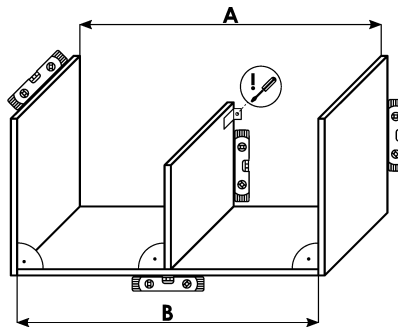

A

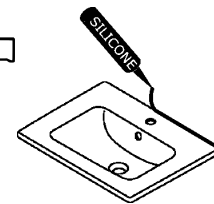
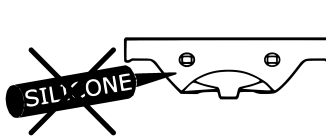
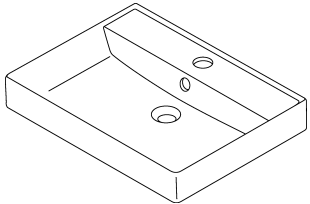

B

