

JOCKAM SZZ2 120 U103



U103

X: 460mm

Y: 390mm

Z: 125mm



X: 1200 mm

Y: 500 mm

Z: 218 mm

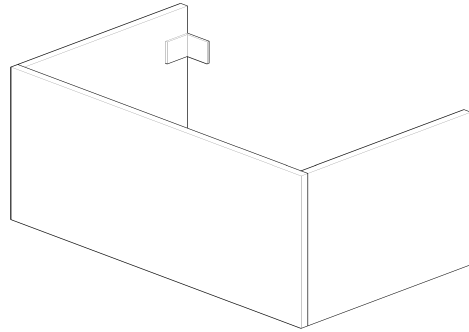
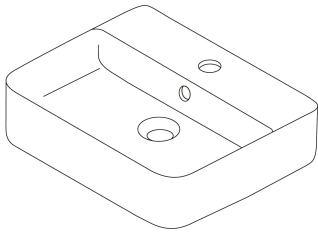

- A 480 mm
- B 620 mm
- C 80-120 mm
- D 300 mm
- E ... mm
- F ... mm
- G 656 mm
- H 656 mm
- I 640 mm
- J 860 mm
- M mm
- N mm

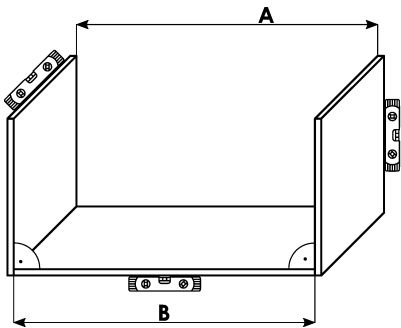
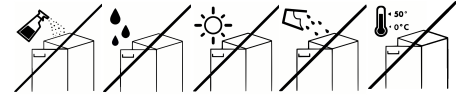
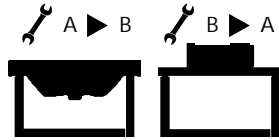
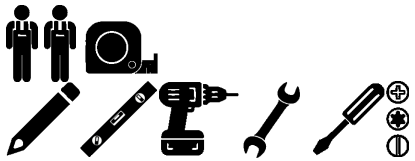
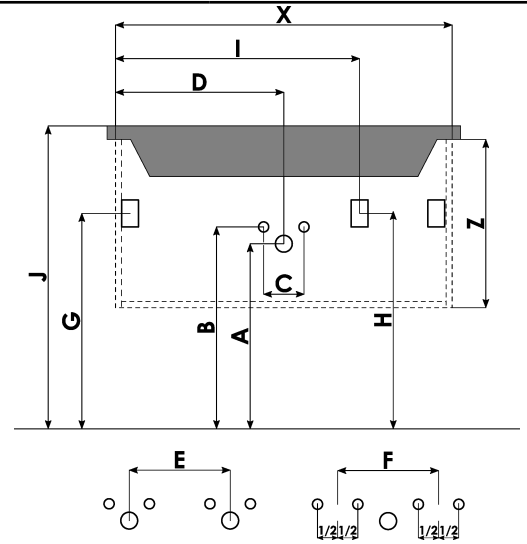

! A=B

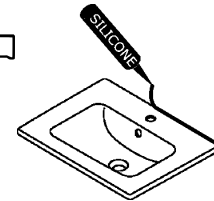
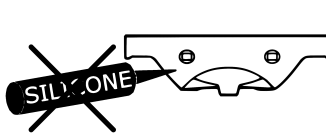
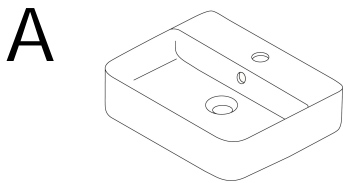
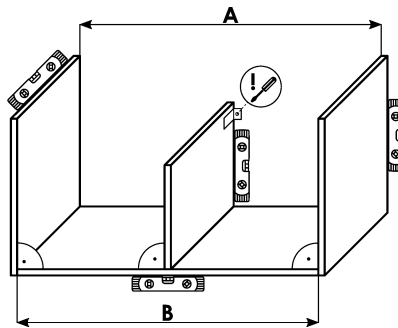

B

