

U103

X₁ 460mm

Y₁ 390mm

Z₁ 125mm

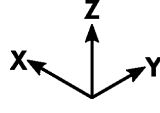

X 2000 mm

Y 500 mm

Z 318 mm

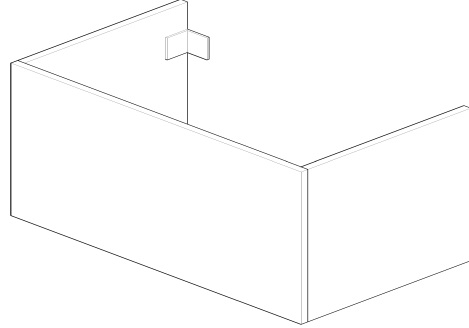
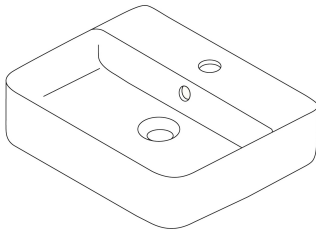

A



A 560 mm
B 600 mm
C 80-120 mm

D 501 mm

E 998 mm

F ... mm

G 656 mm

H 656 mm

I 951/1048/1949 mm

J 860 mm

M mm

N mm

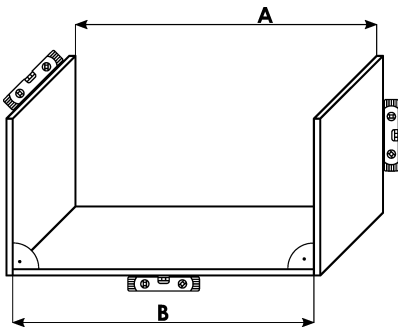
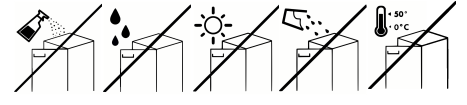
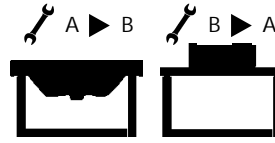
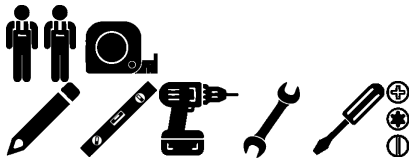
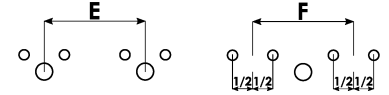
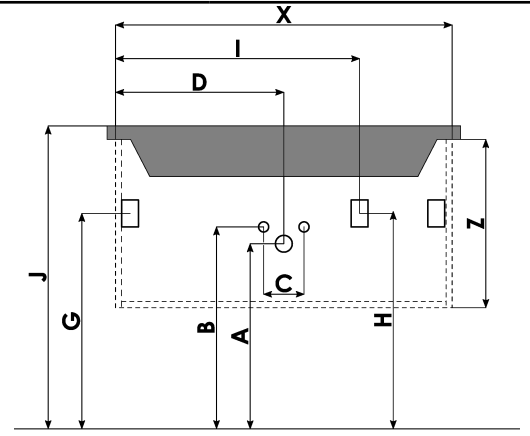

! A=B

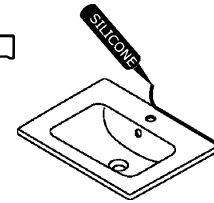
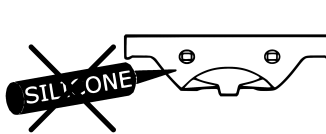
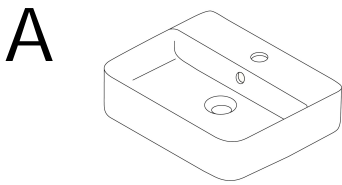
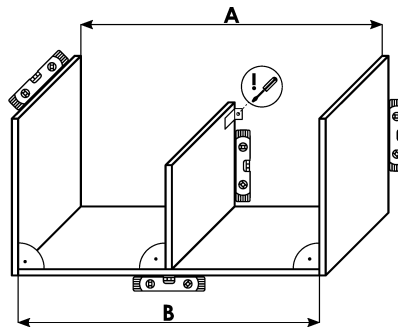

B

