



U023

X: 600mm

Y: 470mm

Z: 130mm



X: 1600 mm

Y: 500 mm

Z: 318 mm

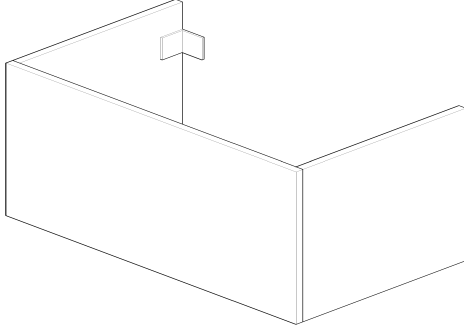
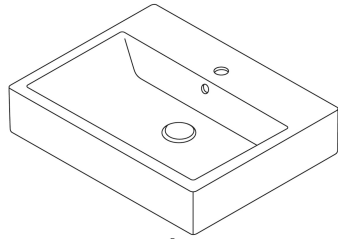

A



- A 560 mm
- B 600 mm
- C 80-120 mm
- D 401 mm
- E 798 mm
- F ... mm
- G 656 mm
- H 656 mm
- I 751/848/1549 mm
- J 860 mm
- M mm
- N mm

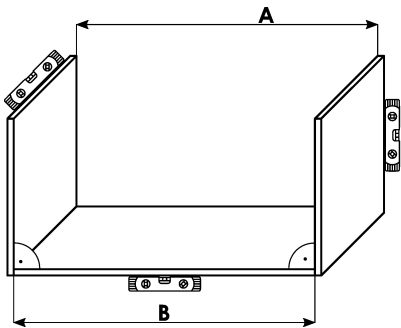
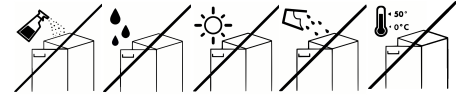
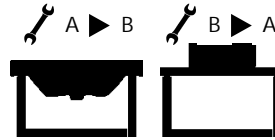
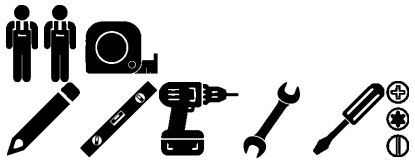
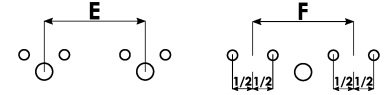
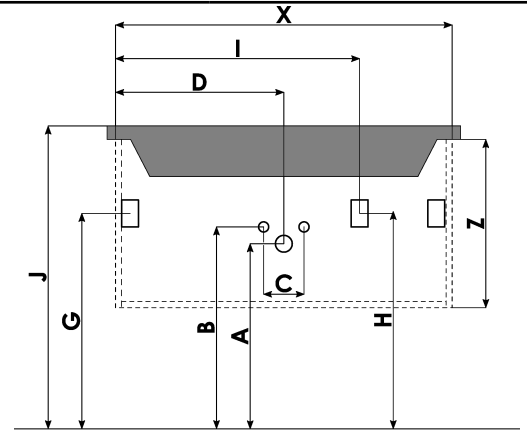

! A=B

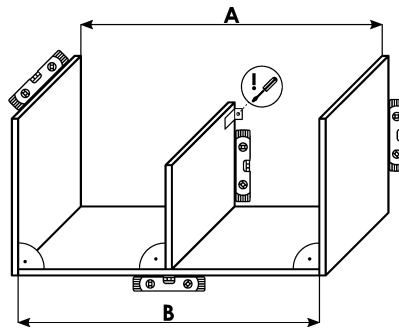

A

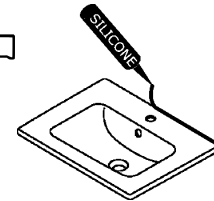
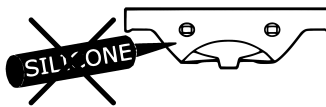
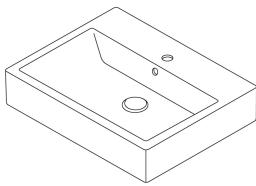

B

