



U023

X: 600mm

Y: 470mm

Z: 130mm

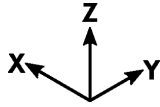

X: 800 mm

Y: 500 mm

Z: 218 mm

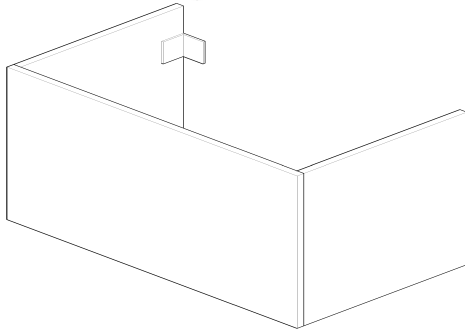
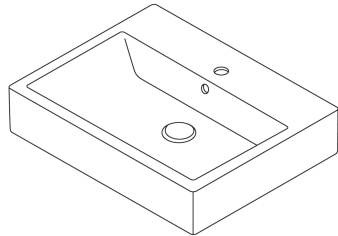

A



- A 560 mm
- B 600 mm
- C 80-120 mm
- D 400 mm
- E --- mm
- F --- mm
- G 656 mm
- H --- mm
- I --- mm
- J 860 mm
- M mm
- N mm

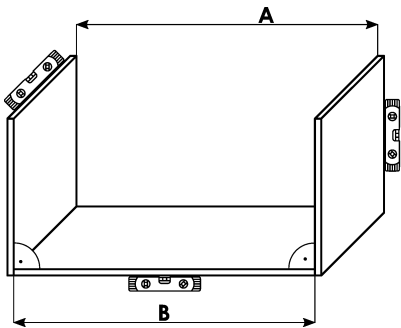
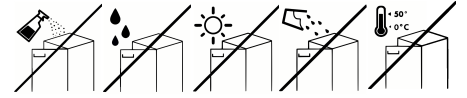
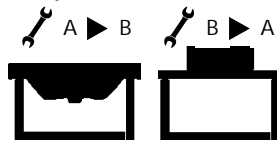
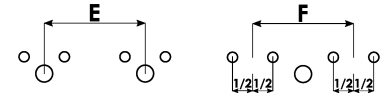
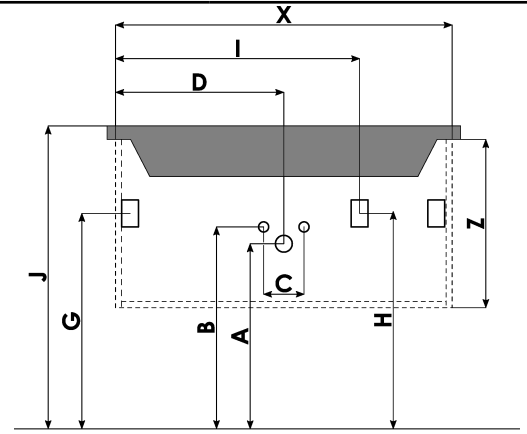

! A=B

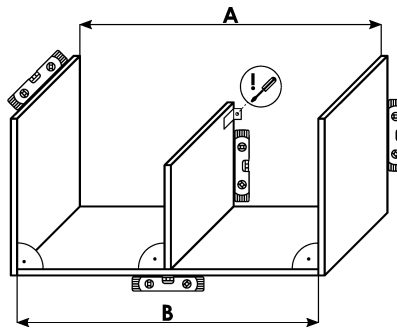

A

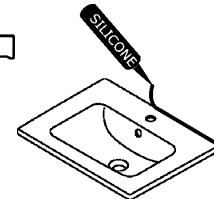
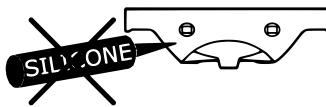
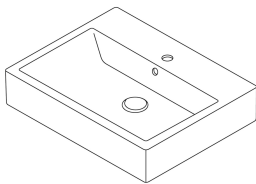

B

