

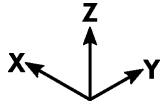



U013

X 1 250 mm  
Y 470 mm  
Z 55 mm

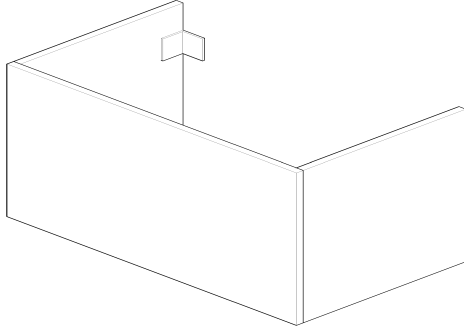
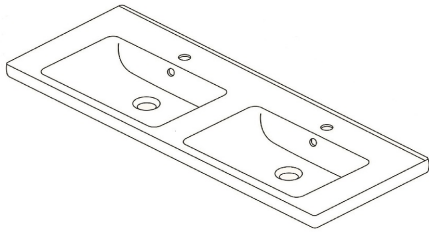

X 1210 mm  
Y 454 mm  
Z 305 mm



A 

X 1210 mm  
Z 305 mm  
A 480 mm  
B 620 mm  
C 80-120 mm  
D 303 mm  
E 605 mm  
F 605 mm  
G 679 mm  
H --- mm  
I --- mm  
J 860 mm

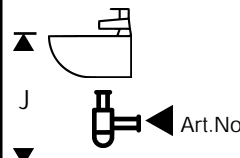
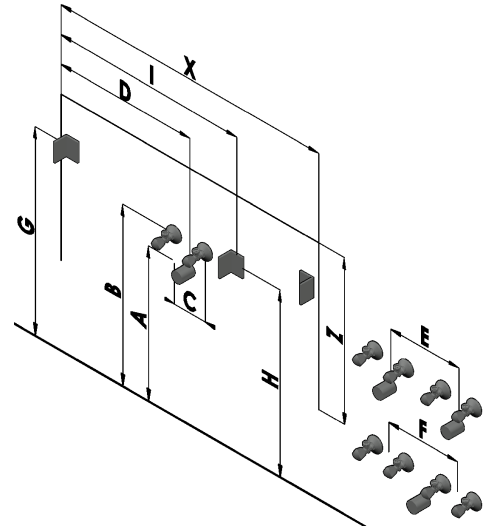

 max. 50 Kg

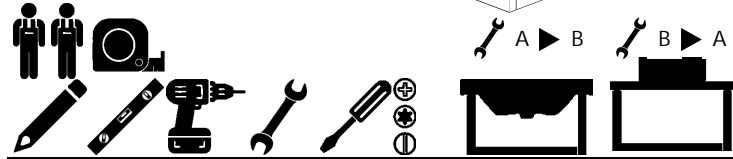
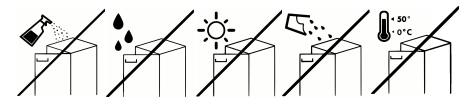

A

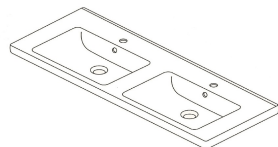

~~SILICONE~~

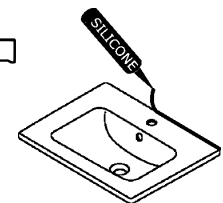

B

