



XXX

X: 0mm

Y: 0mm

Z: 0mm



X 400 mm

Y 500 mm

Z 400 mm

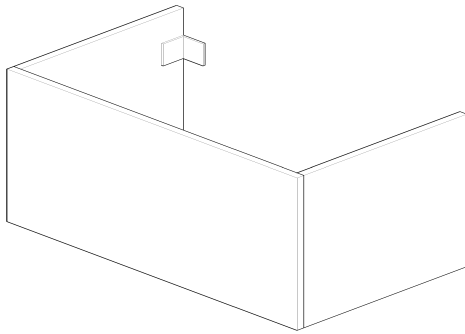

A



A mm

B mm

C 80-120 mm

D mm

E mm

F mm

G mm

H mm

I mm

J 860 mm

M mm

N 31 mm

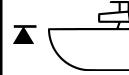
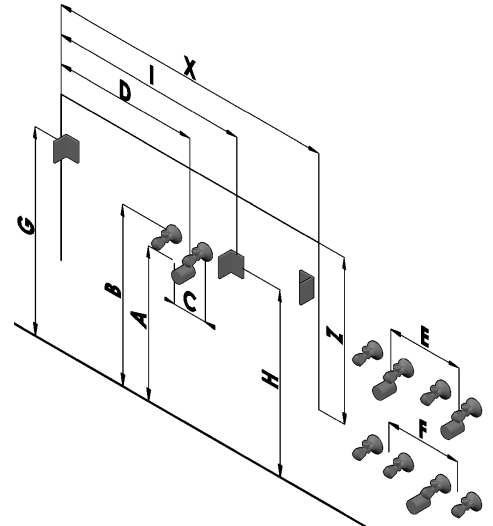

J

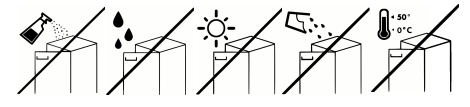
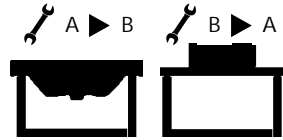
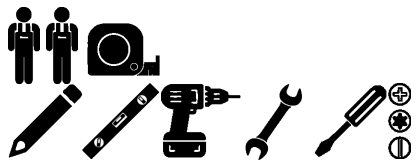

A

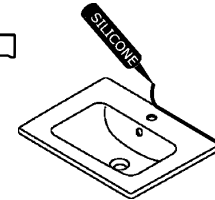

B

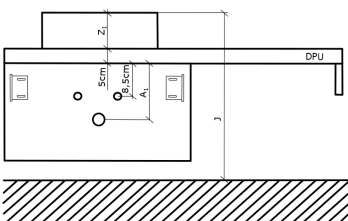
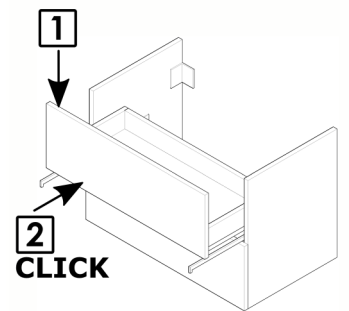
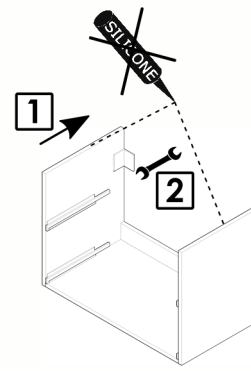
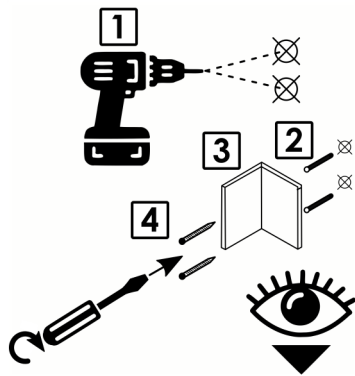
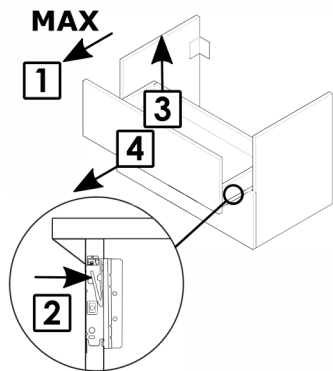

Z₁ = Triumph:

SZZ A₁ = 80 mm

SZZ1 A₁ = 80 mm

SZZ2 A₁ = 80 mm

Z₁ = Kube, Joy, Joy 3:

SZZ A₁ = 230 mm

SZZ1 A₁ = 120 mm

SZZ2 A₁ = 120 mm

