

XXX

X: 0mm

Y: 0mm

Z: 0mm

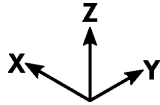

X: 700 mm

Y: 495 mm

Z: 300 mm

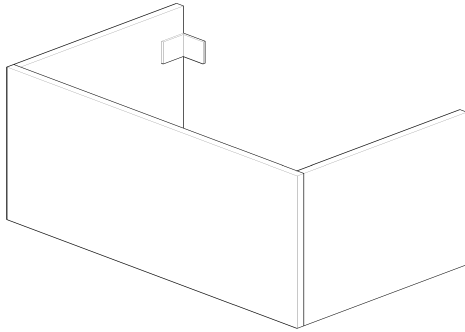

- A mm
- B mm
- C 80-120 mm
- D mm
- E mm
- F mm
- G mm
- H mm
- I mm
- J 860 mm
- M mm
- N 31 mm

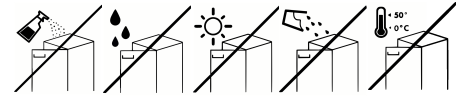
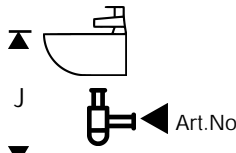
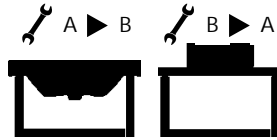
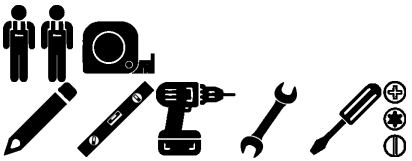
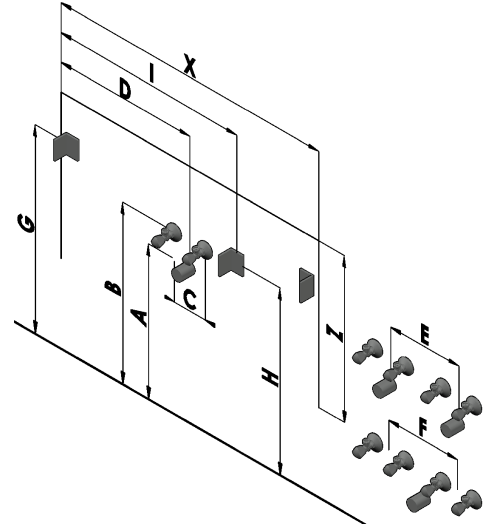

A

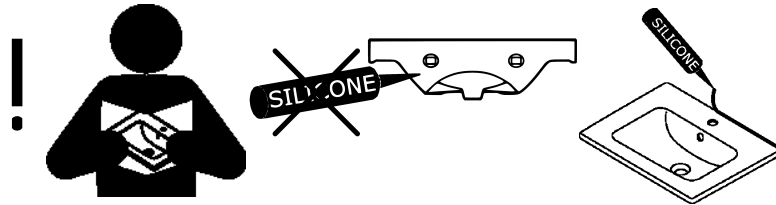

B

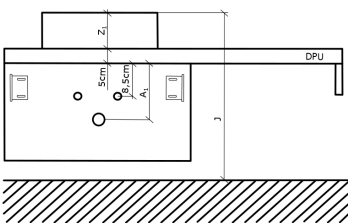
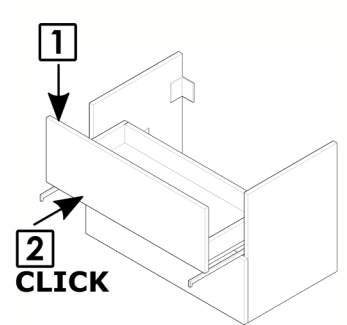
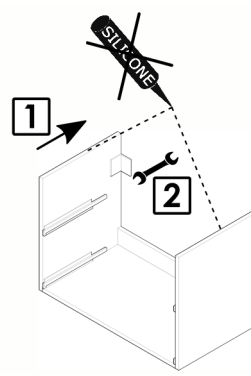
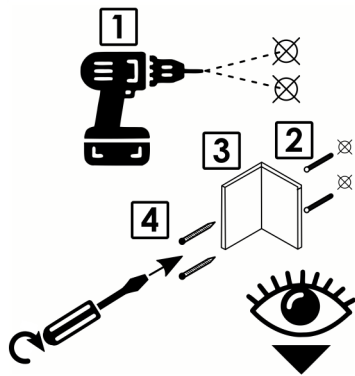
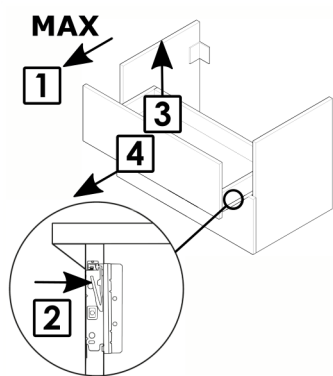

Z₁ = Triumph:

- SZZ A₁ = 80 mm
- SZZ1 A₁ = 80 mm
- SZZ2 A₁ = 80 mm

Z₁ = Kube, Joy, Joy 3:

- SZZ A₁ = 230 mm
- SZZ1 A₁ = 120 mm
- SZZ2 A₁ = 120 mm

