



XXX

X: 0mm

Y: 0mm

Z: 0mm



X: 1000 mm

Y: 495 mm

Z: 200 mm

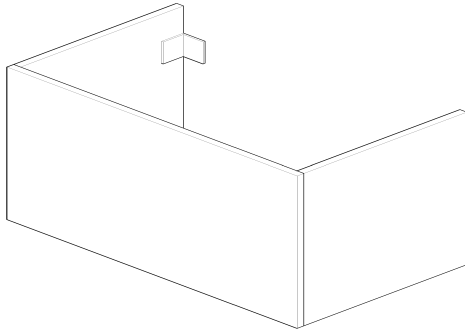

A



B



- A mm
- B mm
- C mm
- D mm
- E mm
- F mm
- G mm
- H mm
- I mm
- J mm
- M mm
- N 31 mm

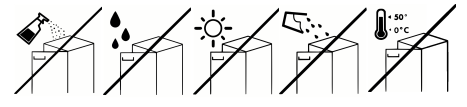
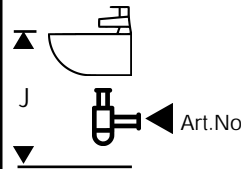
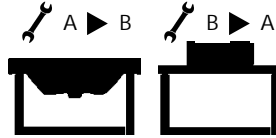
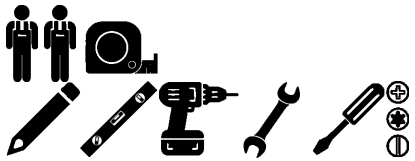
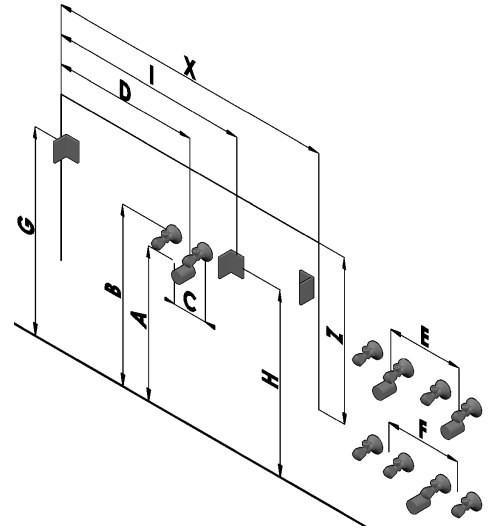

A

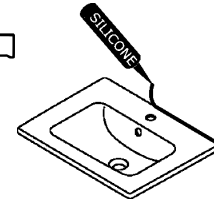
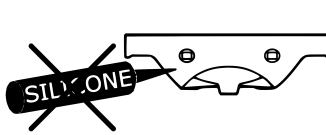

B

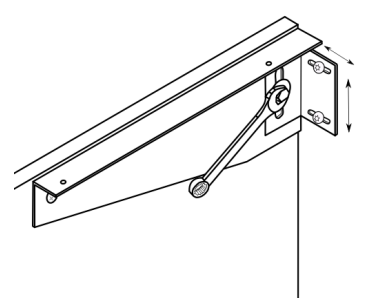
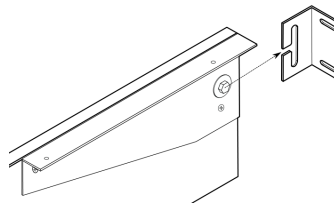
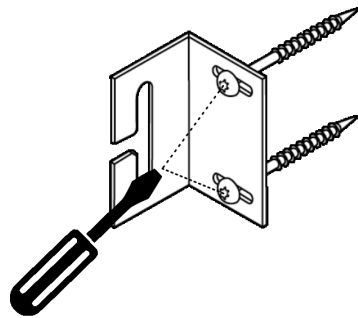
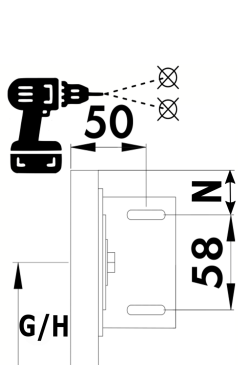
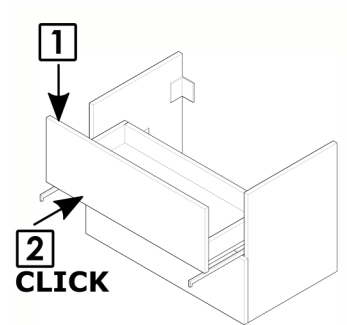
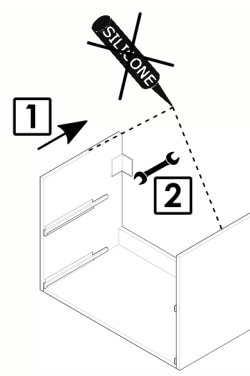
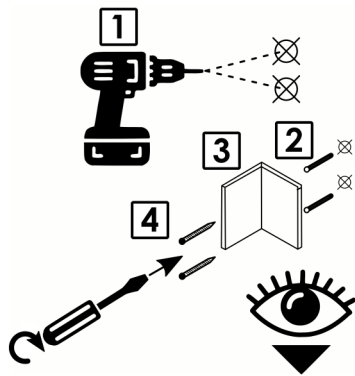
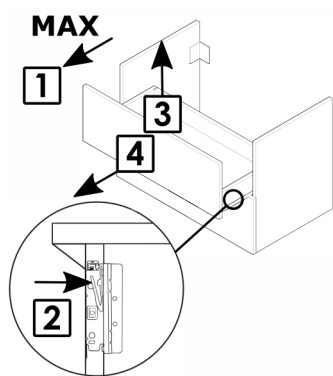

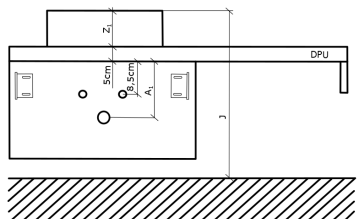

Z₁ = Triumph:

SZZ A₁ = 80 mm
 SZZ1 A₁ = 80 mm
 SZZ2 A₁ = 80 mm

Z₁ = Kube, Joy, Joy 3:

SZZ A₁ = 230 mm
 SZZ1 A₁ = 120 mm
 SZZ2 A₁ = 120 mm

