

X: 0mm

Y: 0mm

Z: 0mm

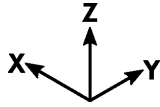

X 598 mm

Y 495 mm

Z 200 mm

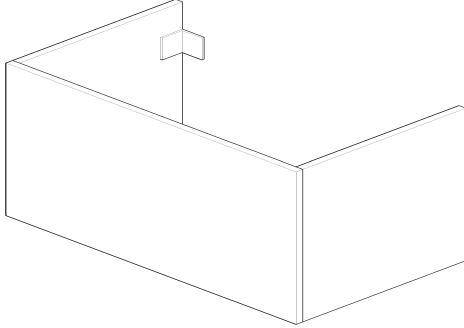

A



A mm

B mm

C mm

D mm

E mm

F mm

G mm

H mm

I mm

J mm

M mm

N 27 mm

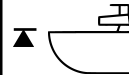
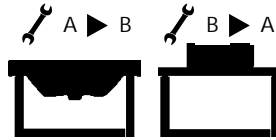
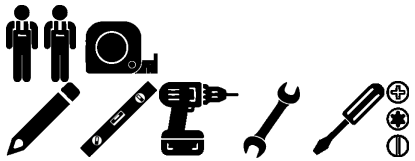
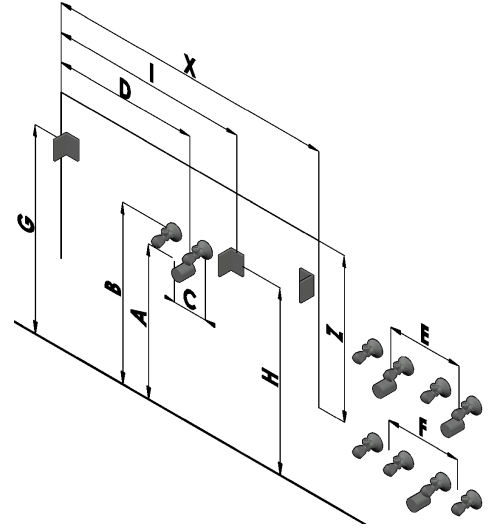

J Art.No

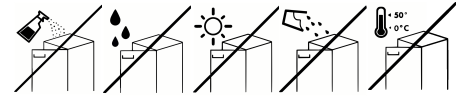

A

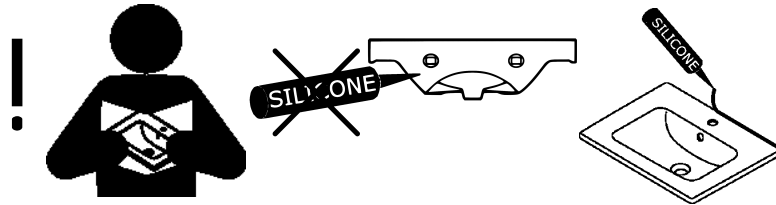

B

