



XXX

X: 0mm

Y: 0mm

Z: 0mm



X 500 mm

Y 445 mm

Z 570 mm

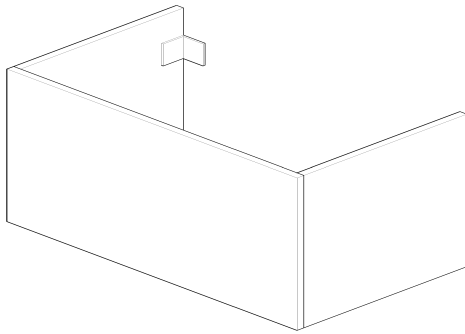

- A mm
- B mm
- C mm
- D mm
- E mm
- F mm
- G mm
- H mm
- I mm
- J mm
- M mm
- N mm

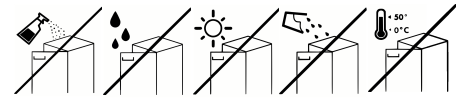
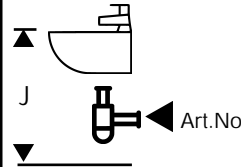
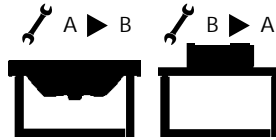
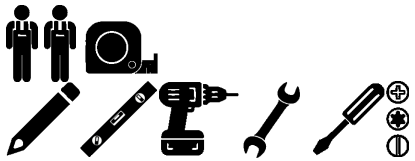
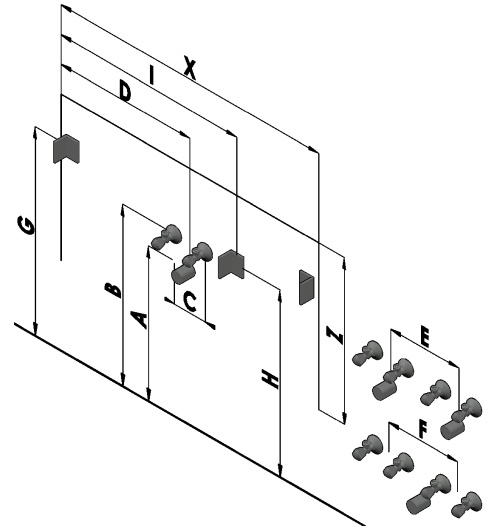

A

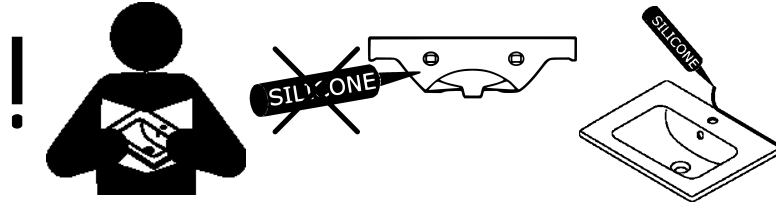

B

